

1. Probušiti betonski stub

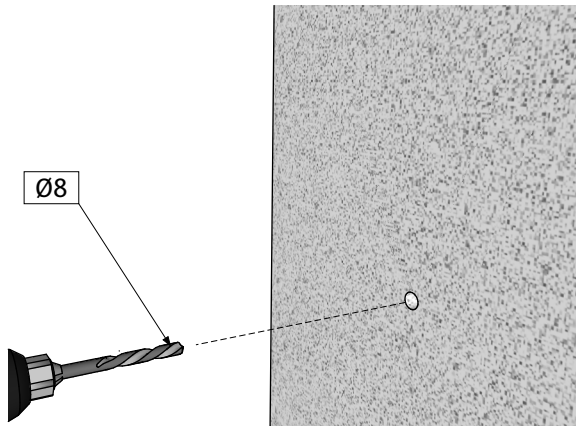

2. Postaviti anker šraf

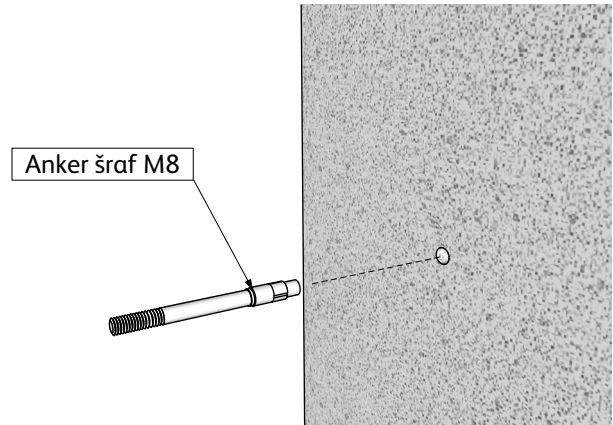

3. Zakucati anker šraf

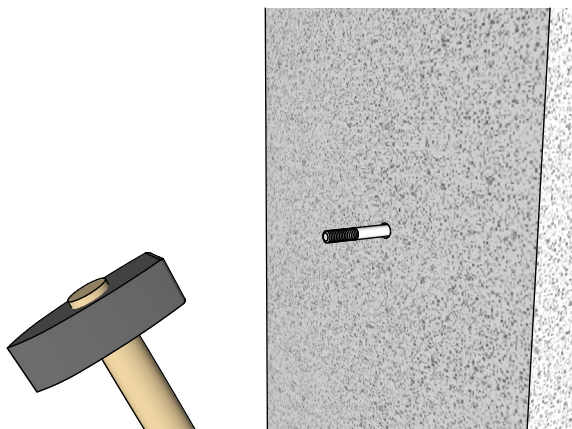

4. Zavrnuti adapter

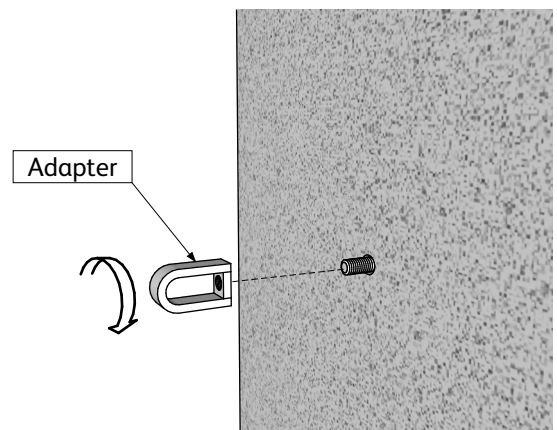

5. Postaviti polja ograde

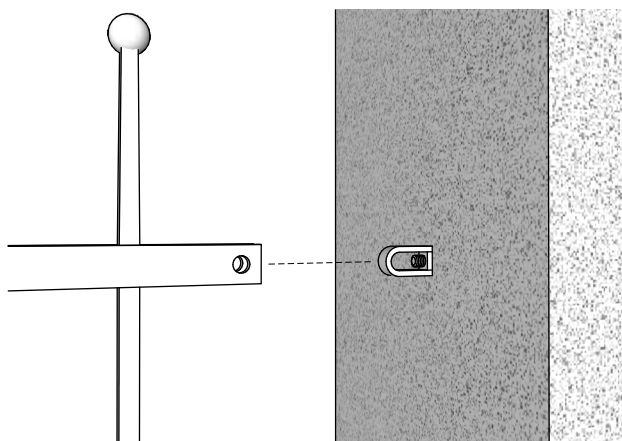

6. Postavit šraf i antivandal navrtku

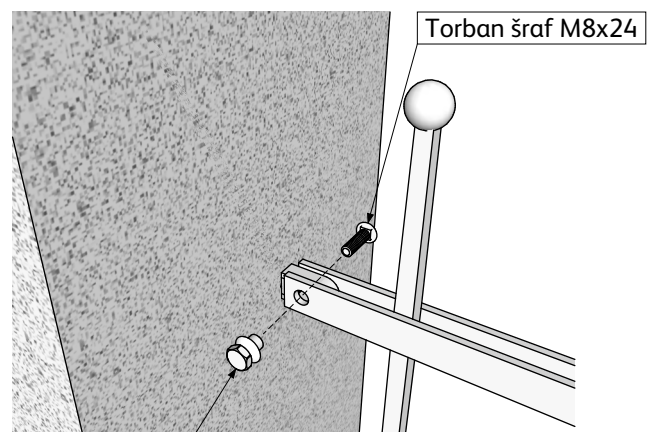

Anti vandal navrtka M8

7. Dotegniti navrtku

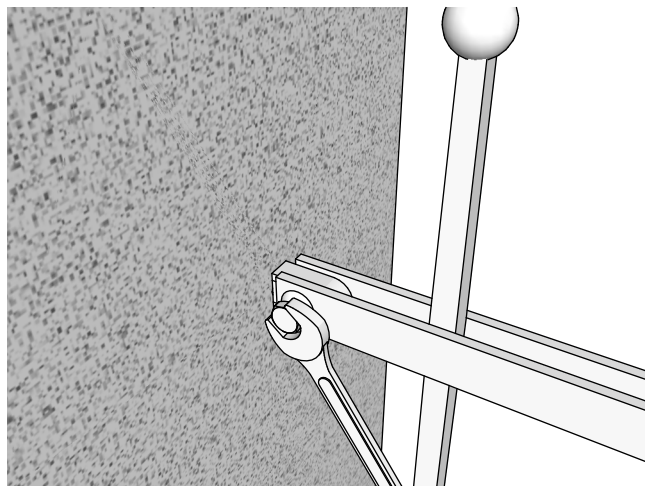

8. Nastaviti sa dotezanjem navrtke dok ne pukne

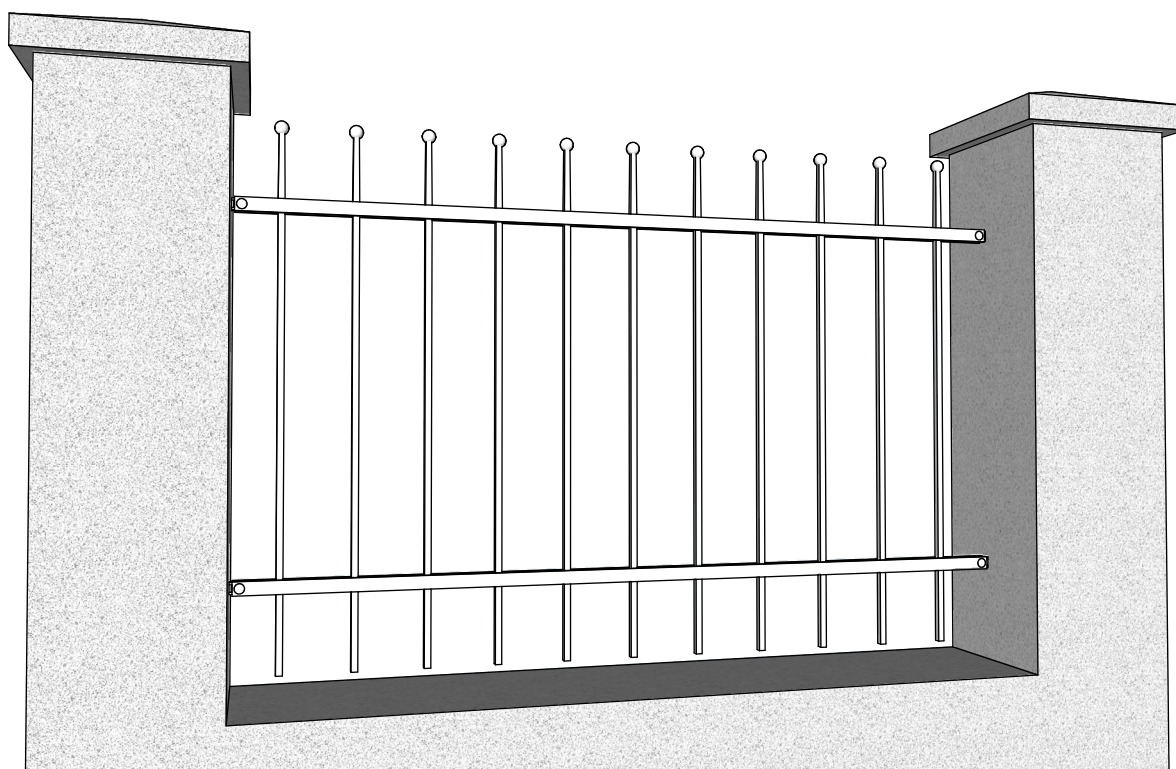
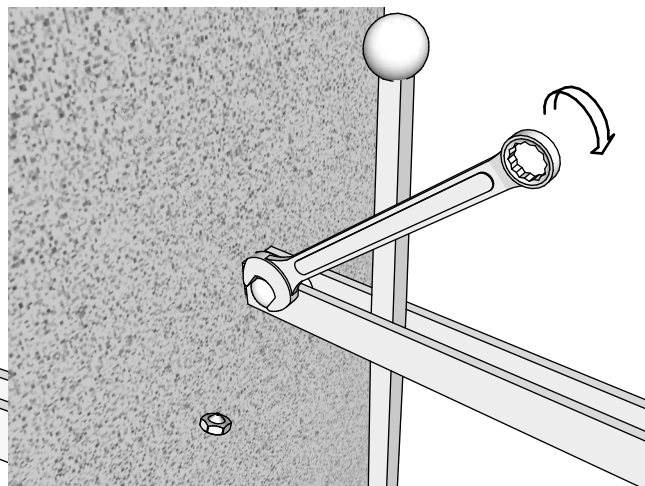

* Umesto anti vandal navrtke moguće je koristiti i običnu M8 navrtku